

USB Type-C DFP 3.0A Controller with BC1.2 Auto-Detection

FEATURES

- 3.0V~5.5V 供电。
- USB Type-C Rev. 1.2 兼容 DFP 控制器
- 支持 Type-C 3.0A 电流
- VBUS 开关控制。
- 支持 Apple®2.7V/2.7V 快速充电模式。
- 支持 Samsung®1.2V/1.2V 快速充电模式。
- 支持 BC1.2&YD/T 1591-2009 充电模式
- 可提供 DFN2*2_8 封装。

APPLICATIONS

- 电源适配器
- 旅行充电器

- 壁式USB充电器
- 移动电源

DESCRIPTION

UC2609是一款Type-C型控制器，专门为充电器和移动充电器的Type-C充电器接口提供CC1，CC2控制型号。它使用USB Type-C 5V协议标准，通过CC1/CC2广播充电器的可用电流，并防止VBUS被断开，直到验证了有效连接。它可以使用Type-C协议进行高达16.5W的充电。

UC2609集成的自动USB充电器识别电路允许移动电源、车载充电器、USB壁式适配器、旅行充电器和其他专用充电器将自己识别为USB设备的USB专用充电器。

UC2609 DFN2*2_8 PACKAGE and SIMPLIFIED APPLICATION

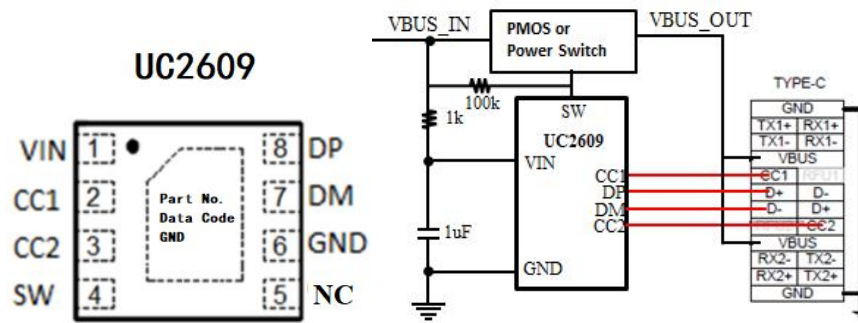

ORDERING INFORMATION

Part Number	Package Type	Package Qty	Op Temp(°C)
UC2609	DFN2*2_8	4000	-40~85

USB Type-C DFP 3.0A Controller with BC1.2 Auto-Detection

MARK INFORMATION & PINOUT

UC2609

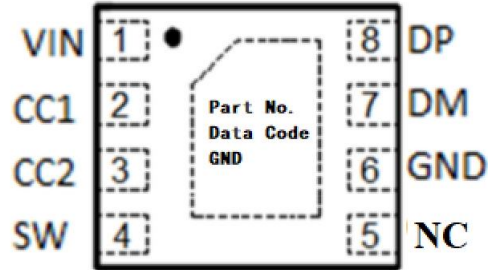

PIN FUNCTIONS

NO.	NAME	TYPE(1)	DESCRIPTION
1	VIN	P/I	Power supply/Input voltage connected to Power Switch; connect a 1 μ F or greater ceramic capacitor from IN to GND as close to the IC as possible
2	CC1	O/I	Analog input/output that connects to the Type-C receptacle CC1 pin
3	CC2	O/I	Analog input/output that connects to the Type-C receptacle CC2 pin
4	SW	O/I	Output Control for VBUS
5	NC	O/I	No Connection or connect Vin
6	GND	G	Ground
7	DM	O/I	DM data line to connector, input for hand-shake voltage from portable equipment high impedance while disabled
8	DP	O/I	DP data line to connector, output for hand-shake voltage to portable equipment, high impedance while disabled

(1) G = GROUND, I = INPUT, O = OUTPUT, P = POWER

USB Type-C DFP 3.0A Controller with BC1.2 Auto-Detection

ABSOLUTE MAXIMUM RATINGS (1)

Over recommended operating free-air temperature range (unless otherwise noted)

PARAMETER		MIN	MAX	UNIT
Supply Voltage Range	VIN	-0.3	7.0	V
Input voltage range	DP,DM,CC1,CC2	-0.3	5.8	
ESD rating, Human Body Model (HBM)	VIN,		7	kV
	DP, DM, CC1,CC2		7	
Operating Junction Temperature	T _j	-40	125	°C
Storage Temperature Range	T _{stg}	-65	150	

(1) Stresses beyond those listed under Absolute Maximum Ratings may cause permanent damage to the device. These are stress ratings only, and functional operation of the device at these or any other conditions beyond those indicated under Recommended Operating Conditions is not implied. Exposure to absolute-maximum-rated conditions for extended periods may affect device reliability.

THERMAL CHARACTERISTICS

Over operating free-air temperature range (unless otherwise noted)

THERMAL METRIC			UNIT
θJA	DFN2*2_8 Package thermal impedance(1)	80	°C/W

(1) The package thermal impedance is calculated in accordance with JESD 51-7.

RECOMMENDED OPERATING CONDITIONS

PARAMETER		MIN	MAX	UNIT
VIN	Input voltage of IN	4.5	6.5	V
VDP/DM	DP data line input voltage		5.5	
IDP/DM	Continuous sink/source current		±10	mA
TJ	Operating Junction Temperature	-40	125	°C

USB Type-C DFP 3.0A Controller with BC1.2 Auto-Detection

ELECTRICAL CHARACTERISTICS

Conditions are: T_a = 25°C, V_s = 5.0 V. Positive current are into pins. All voltages are with respect to GND (unless otherwise noted).

PARAMETER		TEST CONDITIONS	MIN	TYP	MAX	UNIT
SUPPLY CURRENT						
I _{IN}	VIN ON supply current			230		μA
I _{INI}	VIN idle supply current	CC1/CC2 floating		0	5	
BC 1.2 DCP MODE						
R _{DPM_SHORT}	DP / DM shorting resistance			125	200	Ω
IPAD MODE 2.4A Mode						
V _{DP_IPAD}	DP output voltage		2.5	2.7	2.9	V
V _{DM_IPAD}	DM output voltage		2.5	2.7	2.9	V
Galaxy Tab MODE						
V _{DP_GAL}	DP output voltage		1.1	1.2	1.3	V
V _{DM_GAL}	DM output voltage		1.1	1.2	1.3	

USB Type-C DFP 3.0A Controller with BC1.2 Auto-Detection

PACKAGE INFORMATION

DFN-2x2_8

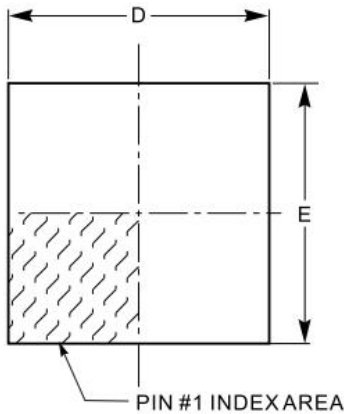

TOP VIEW

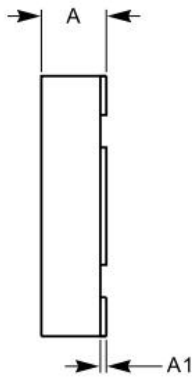

SIDE VIEW

SYMBOL	MIN	NOM	MAX
A	0.70	0.75	0.80
A1	0.00	0.02	0.05
b	0.18	0.25	0.30
D	2.00BSC		
D1	1.10	1.20	1.30
E	2.00BSC		
E1	0.50	0.60	0.70
e	0.50 BSC		
L	0.30	0.35	0.40

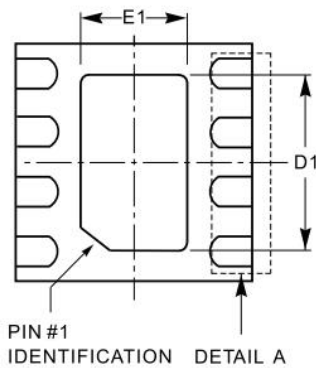

BOTTOM VIEW

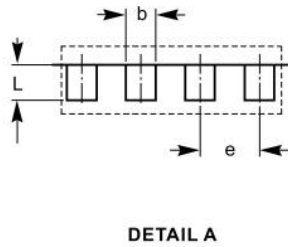

DETAIL A

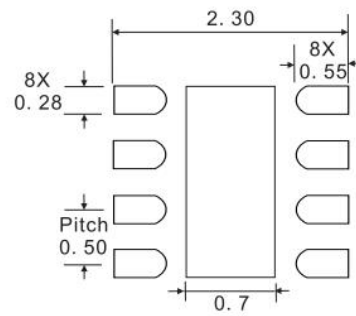

UNIT: mm

Recommended Land Pattern

Notes:

- (1) 所有尺寸都为毫米
- (2) 参考JEDEC MO-229标准